

# NEON POOL

**GUIDA ALL'INSTALLAZIONE DELLA PISCINA**  
INDICATIONS FOR POOL INSTALLATION



## NEON POOL TOP e SIDE / NEON POOL TOP and SIDE

### Sistema Triple-Seal IP68: massima protezione contro acqua, cloro e salinit .

In Luz Negra prendiamo molto seriamente la sicurezza nelle applicazioni che combinano elettricit  e umidit , soprattutto in ambienti particolarmente esigenti come piscine, aree esposte al cloro o installazioni in presenza di salinit . Per questo abbiamo sviuppato un esclusivo sistema di sigillatura Triple-Seal, progettato per garantire una tenuta stagna certificata IP68, conforme ai principali standard internazionali **UL** e **CE**.

Il progetto di sigillatura si sviluppa in tre fasi:

1. Sigillatura interna della strip LED.
2. Incapsulamento delle estremit  del profilo Neon.
3. Applicazione di una sigillatura esterna ad alta resistenza.

Questo sistema assicura massima affidabilit , durata e performance costanti anche nelle condizioni pi  estreme. A causa dell'elevata complessit  del processo produttivo, i **tempi di realizzazione sono di circa 4-6 settimane**. Per motivi di garanzia e sicurezza, il prodotto non pu  essere tagliato o modificato dal cliente dopo la produzione.

Al momento dell'ordine   necessario specificare:

- **Lunghezza esatta del segmento LED.**
- **Lunghezza del cavo di alimentazione.**

Inoltre, verr  fornito un breve questionario tecnico da compilare, indispensabile per configurare il prodotto in modo preciso e perfettamente adatto alle esigenze del progetto.

In Luz Negra, **qualit  e affidabilit ** sono sempre la nostra massima priorit .



Triple-Seal IP68 System: maximum protection against water, chlorine, and salinity

Here at Luz Negra, we take the risks of combining electricity and moisture very seriously, especially in demanding environments such as swimming pools or installations exposed to chlorine and salt. That's why we have developed an exclusive triple-seal system that ensures IP68-rated watertightness and fully compliant with leading international standards such as UL and CE.

Our sealing process is carried out in three stages:

1. Internal sealing of the LED strip.
2. Encapsulation of the neon profile ends.
3. Application of a high-resistance external seal.

This system guarantees maximum durability and reliability, even under extreme conditions.

Due to the complexity of the process, the **lead time is 4 to 6 weeks**. Additionally, for warranty reasons, the product cannot be cut or modified by the customer once manufactured.

When placing an order, it is essential to specify:

- **Exact length of the LED segment.**
- **Length of the power cable.**

A short technical questionnaire will also be provided and must be completed to ensure the product is tailored precisely to the project requirements.

Here at Luz Negra, **quality and reliability** are always our top priority.

# NEON POOL TOP e SIDE / NEON POOL TOP and SIDE

GUIDA ALL'INSTALLAZIONE DELLA PISCINA / INDICATIONS FOR POOL INSTALLATION

Contrassegnare con una "X" nell'apposita casella  
Mark with an 'X' in the box



## 1. Temperatura di colore richiesta / Colour temperature required



## 2. Tipologia di Neon Pool richiesta / Type of Neon Pool required

Neon Pool **TOP**

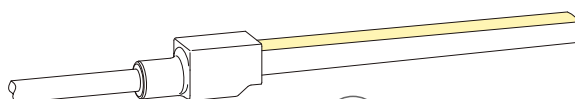
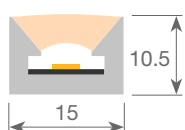

Uscita cavo **FRONTALE** / FRONT cable outlet

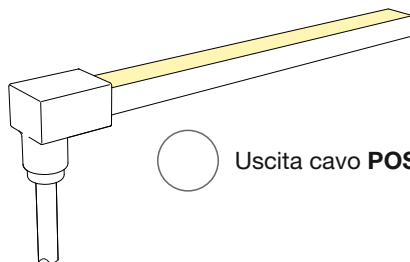

Uscita cavo **POSTERIORE** / BACK cable outlet

Neon Pool **SIDE**

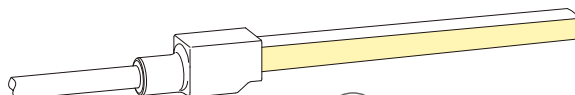
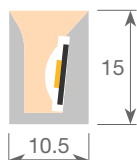

Uscita cavo **FRONTALE** / FRONT cable outlet

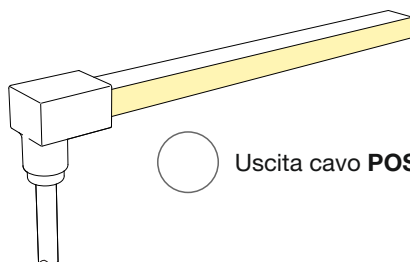

Uscita cavo **POSTERIORE** / BACK cable outlet

Ragione sociale / Fiscal name :

Offerta - Ordine / Offer - Order :

Firma / Signature :

Note / Notes :

# NEON POOL TOP e SIDE / NEON POOL TOP and SIDE

## GUIDA ALL'INSTALLAZIONE DELLA PISCINA / INDICATIONS FOR POOL INSTALLATION

**3. Quanto é lunga ciascuna striscia della piscina? / How long is each strip of the pool?  
Che tipo di uscita cavo richiede ciascuna sezione? / What type of cable outlet does each section require?**

- Tipologie di uscita cavo / Types of cable outlet

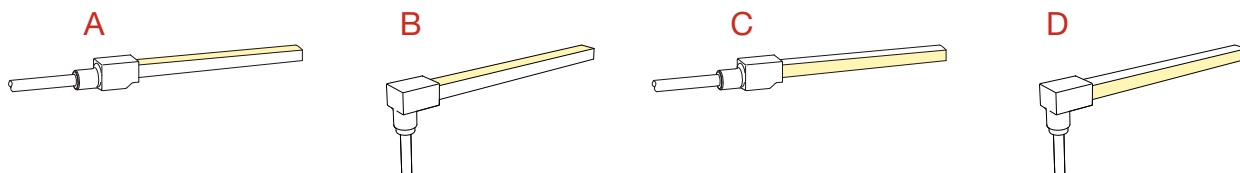

- Estremitá dell'uscita cavo e lunghezza della striscia / Cable outlet ends and length of the strip

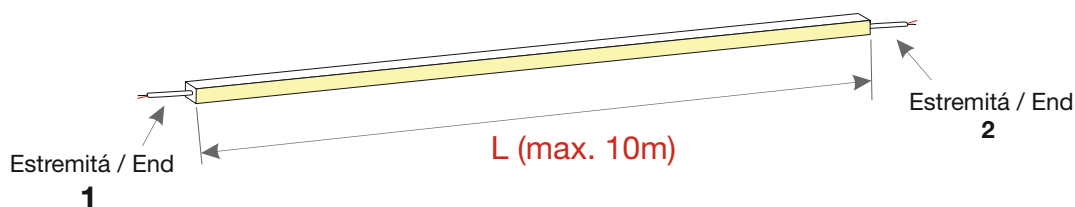

Numero di sezioni / Number of sections : \_\_\_\_\_

Sezione / Section 1

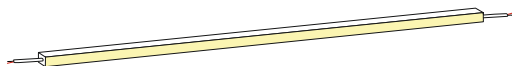

Lunghezza della striscia (m) / Strip length (m) : \_\_\_\_\_

Tipologia di estremitá dell'uscita cavo 1 / Type of cable outlet end 1 : \_\_\_\_\_

Tipologia di estremitá dell'uscita cavo 2 / Type of cable outlet end 2 : \_\_\_\_\_

Sezione / Section 2

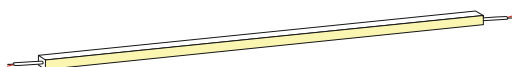

Lunghezza della striscia (m) / Strip length (m) : \_\_\_\_\_

Tipologia di estremitá dell'uscita cavo 1 / Type of cable outlet end 1 : \_\_\_\_\_

Tipologia di estremitá dell'uscita cavo 2 / Type of cable outlet end 2 : \_\_\_\_\_

Sezione / Section 3



Lunghezza della striscia (m) / Strip length (m) : \_\_\_\_\_

Tipologia di estremitá dell'uscita cavo 1 / Type of cable outlet end 1 : \_\_\_\_\_

Tipologia di estremitá dell'uscita cavo 2 / Type of cable outlet end 2 : \_\_\_\_\_

Sezione / Section 4

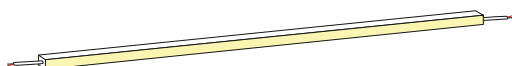

Lunghezza della striscia (m) / Strip length (m) : \_\_\_\_\_

Tipologia di estremitá dell'uscita cavo 1 / Type of cable outlet end 1 : \_\_\_\_\_

Tipologia di estremitá dell'uscita cavo 2 / Type of cable outlet end 2 : \_\_\_\_\_

# NEON POOL TOP e SIDE / NEON POOL TOP and SIDE

## GUIDA ALL'INSTALLAZIONE DELLA PISCINA / INDICATIONS FOR POOL INSTALLATION



Sezione / Section **5**

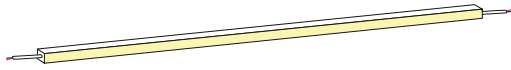

Lunghezza della striscia (m) / Strip length (m) : \_\_\_\_\_

Tipologia di estremità dell'uscita cavo 1 / Type of cable outlet end 1 : \_\_\_\_\_

Tipologia di estremità dell'uscita cavo 2 / Type of cable outlet end 2 : \_\_\_\_\_



Sezione / Section **6**

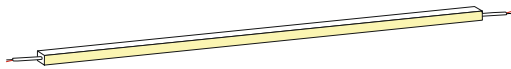

Lunghezza della striscia (m) / Strip length (m) : \_\_\_\_\_

Tipologia di estremità dell'uscita cavo 1 / Type of cable outlet end 1 : \_\_\_\_\_

Tipologia di estremità dell'uscita cavo 2 / Type of cable outlet end 2 : \_\_\_\_\_



Sezione / Section **7**

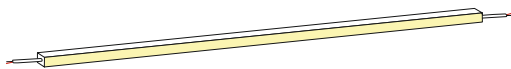

Lunghezza della striscia (m) / Strip length (m) : \_\_\_\_\_

Tipologia di estremità dell'uscita cavo 1 / Type of cable outlet end 1 : \_\_\_\_\_

Tipologia di estremità dell'uscita cavo 2 / Type of cable outlet end 2 : \_\_\_\_\_



Sezione / Section **8**

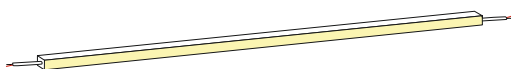

Lunghezza della striscia (m) / Strip length (m) : \_\_\_\_\_

Tipologia di estremità dell'uscita cavo 1 / Type of cable outlet end 1 : \_\_\_\_\_

Tipologia di estremità dell'uscita cavo 2 / Type of cable outlet end 2 : \_\_\_\_\_



Sezione / Section **9**

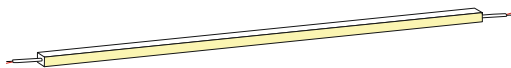

Lunghezza della striscia (m) / Strip length (m) : \_\_\_\_\_

Tipologia di estremità dell'uscita cavo 1 / Type of cable outlet end 1 : \_\_\_\_\_

Tipologia di estremità dell'uscita cavo 2 / Type of cable outlet end 2 : \_\_\_\_\_



Sezione / Section **10**

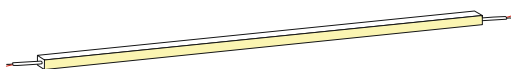

Lunghezza della striscia (m) / Strip length (m) : \_\_\_\_\_

Tipologia di estremità dell'uscita cavo 1 / Type of cable outlet end 1 : \_\_\_\_\_

Tipologia di estremità dell'uscita cavo 2 / Type of cable outlet end 2 : \_\_\_\_\_



Sezione / Section **11**

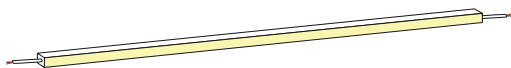

Lunghezza della striscia (m) / Strip length (m) : \_\_\_\_\_

Tipologia di estremità dell'uscita cavo 1 / Type of cable outlet end 1 : \_\_\_\_\_

Tipologia di estremità dell'uscita cavo 2 / Type of cable outlet end 2 : \_\_\_\_\_



Sezione / Section **12**

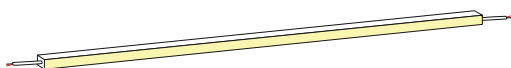

Lunghezza della striscia (m) / Strip length (m) : \_\_\_\_\_

Tipologia di estremità dell'uscita cavo 1 / Type of cable outlet end 1 : \_\_\_\_\_

Tipologia di estremità dell'uscita cavo 2 / Type of cable outlet end 2 : \_\_\_\_\_

# NEON POOL TOP e SIDE / NEON POOL TOP and SIDE

GUIDA ALL'INSTALLAZIONE DELLA PISCINA / INDICATIONS FOR POOL INSTALLATION

## 4. Tipologia di forma della piscina / Type of pool shape

Forme curve / Curved shapes

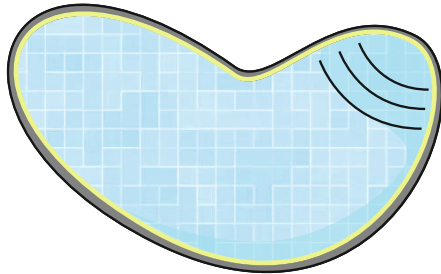

Forme rettilinee / Straight shapes

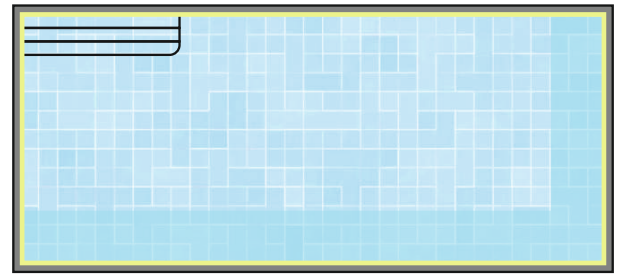

## 5. Dove verranno posizionate le strisce? / Where will the strips be placed?

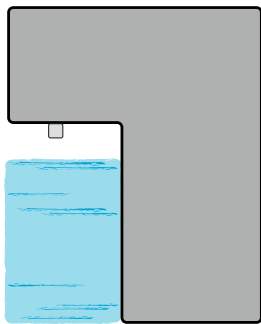

Sulla superficie, sotto il bordo in ceramica. /  
On the surface, under the ceramic edge.

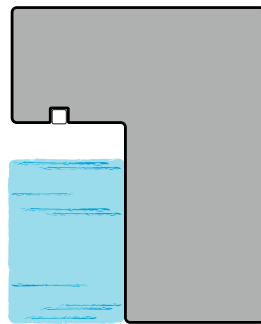

Incassato, sotto il bordo in ceramica. /  
Recessed, under the ceramic edge.

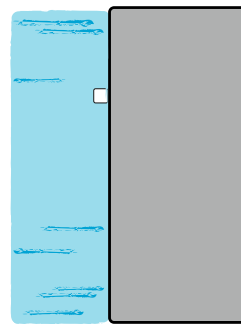

In superficie, a parete. /  
On the surface, wall mounted.



**ATTENZIONE! / ATTENTION!**

Non raccomandato per piscine; solo per aree prive di accesso o fonti d'acqua. /  
Not recommended for swimming pools, only for areas without access or water sources.

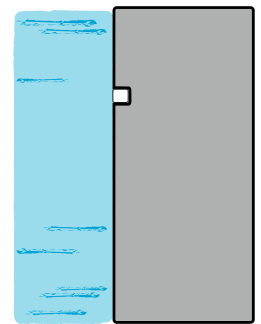

Incassato a parete. /  
Recessed, wall mounted.

## 6. Nel caso di scelta delle ultime due opzioni del punto precedente, a quale profondità verrà installata la striscia? / In the case of choosing the last two options in the previous point, at what depth will the strip be installed?

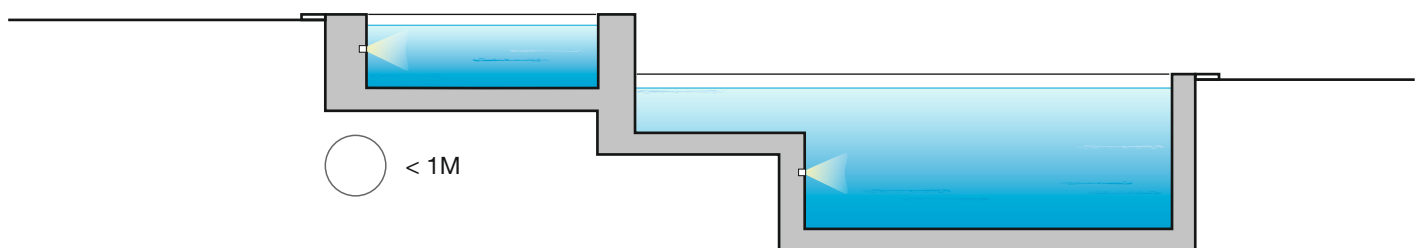

< 1M

1M a 2M / 1M to 2M

## NEON POOL TOP e SIDE / NEON POOL TOP and SIDE

GUIDA ALL'INSTALLAZIONE DELLA PISCINA / INDICATIONS FOR POOL INSTALLATION

7. Utilizzando uno degli esempi, dove verranno posizionate le strisce del punto 3 ? /  
Using one of the examples, where will the strips in point 3 be placed?

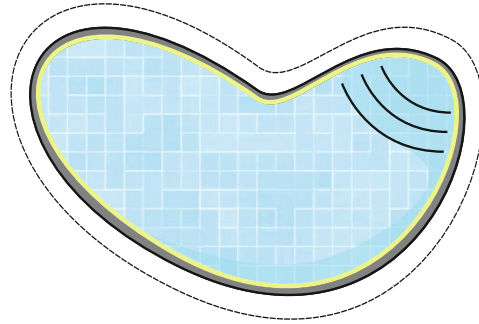
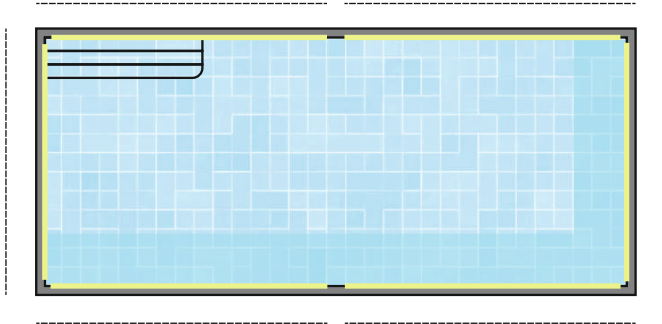

**ATTENZIONE! / ATTENTION!**

Il raggio minimo di curvatura agli angoli é di 120mm. /  
The minimum bending radius at corners is 120 mm.

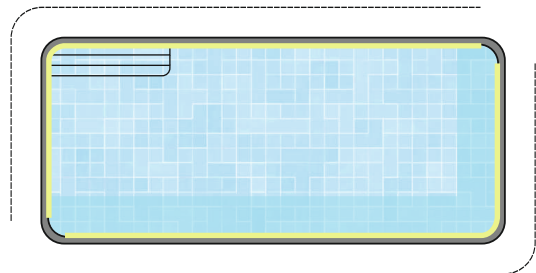
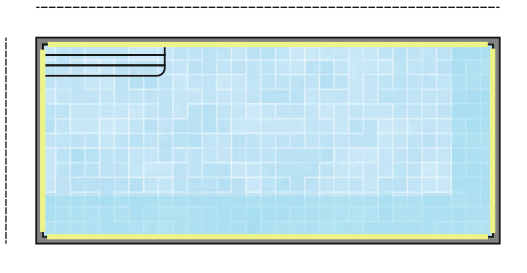

8. Dove si trovano i pozzetti che alloggiano le scatole di giunzione elettrica intermedie? /  
Where are the handholes that house the intermediate electrical junction boxes?

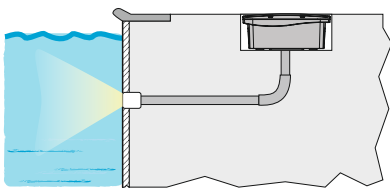

Incassati nel terreno, sopra il livello  
del'acqua. /  
Recessed in the ground, above  
water level.

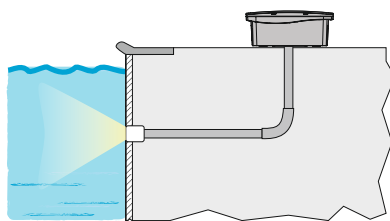

In superficie, sopra il livello  
dell'acqua. /  
Surface, above water level.

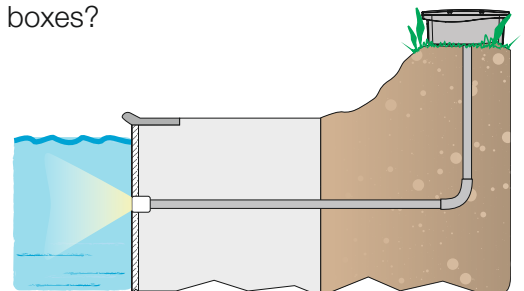

In superficie, sfruttando le dislivellature del  
terreno. / On the surface, taking advantage of  
the unevenness of the terrain.

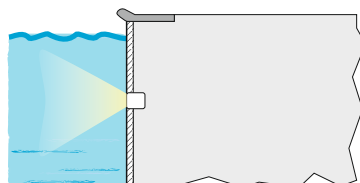

Nessuna scatola intermedia, collegamento diretto  
alla zona apparecchiature. /  
No intermediate boxes, direct to the equipment area.

# NEON POOL TOP e SIDE / NEON POOL TOP and SIDE

## GUIDA ALL'INSTALLAZIONE DELLA PISCINA / INDICATIONS FOR POOL INSTALLATION

- 9. Quali sono le dimensioni dei pozzetti che ospiteranno le scatole di giunzione? / How big are the handholes that will house the junction boxes?**

L ..... x A ..... x H ..... (cm) \*

\* Dimensioni interne / Inside dimensions

- 10. Qual é la distanza dal pozzetto all'inizio della striscia? / What is the distance from the handhole to the beginning of the strip?**

D = ..... (cm)

- 11. Qual é la sezione del tubo che collega il pozzetto alla striscia? / What is the cross-section of the tube connecting the handhole to the strip?**

Ø = ..... (cm)

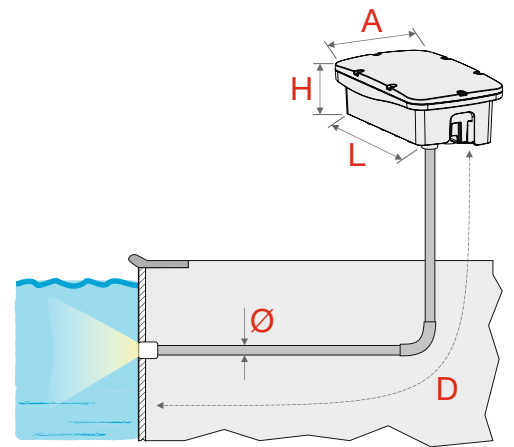

- 12. Indicare se l'installazione presenta una delle seguenti caratteristiche relative al posizionamento del pozzetto e del tubo che lo collega alla striscia. / Indicate if your installation has any of the following characteristics regarding the placement of the handhole and the tube that connects them to the strip.**

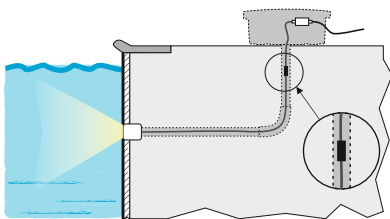

Ogni punto di alimentazione delle strisce é dotato di un tubo corrugato indipendente. / Each feeding point of the strips is provided with an independent conduit.

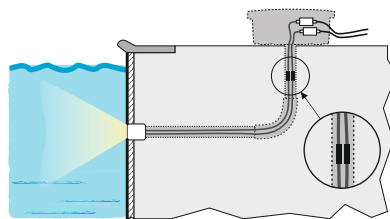

Esistono punti di alimentazione che condividono lo stesso tubo, con sezione sufficiente a contenere entrambe le valvole. / There are feeding points that share the same tube and with sufficient cross-section to contain both valves.

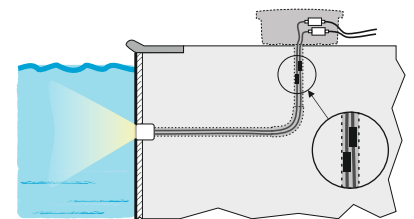

Esistono punti di alimentazione che condividono lo stesso tubo, ma le valvole devono essere disposte in sequenza (in scala) a causa della mancanza di spazio nella sezione del tubo. / There are feeding points that share the same tube, but the valves must be placed in valve scaling due to the lack of space in the cross-section tube.

- 13. Dove sono posizionati gli alimentatori e le apparecchiature di controllo? / Where are the power supplies and control equipment located?**



**A** In superficie, accanto alla piscina. / On the surface, next to the pool.



**B** Interrati, a bordo piscina. / Underground, by the pool.



**C** In un edificio secondario o all'interno della casa. / In a secondary building or inside the house.

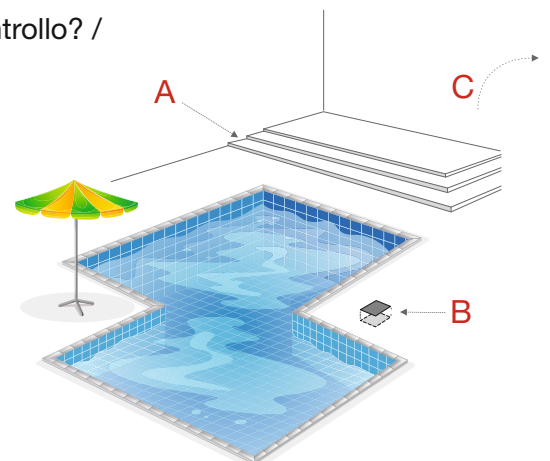

## NEON POOL TOP e SIDE / NEON POOL TOP and SIDE

GUIDA ALL'INSTALLAZIONE DELLA PISCINA / INDICATIONS FOR POOL INSTALLATION

14. Quali sono le distanze dalla posizione delle apparecchiature (A) ai pozzetti intermedi (B)? /  
What are the distances from the location of the equipment (A) to the intermediate boxes (B)?

D1 = ..... (cm)

D2 = ..... (cm)

D3 = ..... (cm)

D4 = ..... (cm)

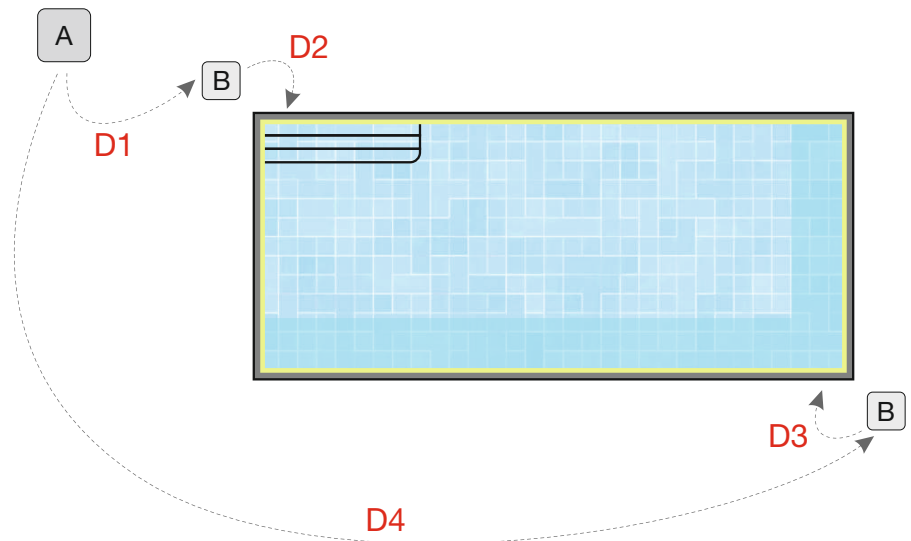

15. Quale tecnologia di controllo é necessaria nell'installazione? /  
What control technology is needed in the installation?

ON/OFF - Nessuna regolazione /  
ON/OFF - No regulation

DALI

CASAMBI

RF - Radiofrequenza /  
RF - Radio Frequency

DMX

Altro / Others .....